

Rohbaumaß

lichter Zargendurchgang

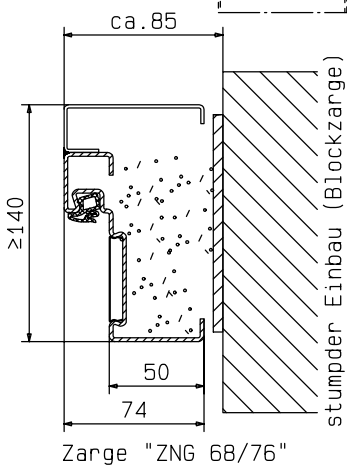

Zarge "ZNG 68/76"

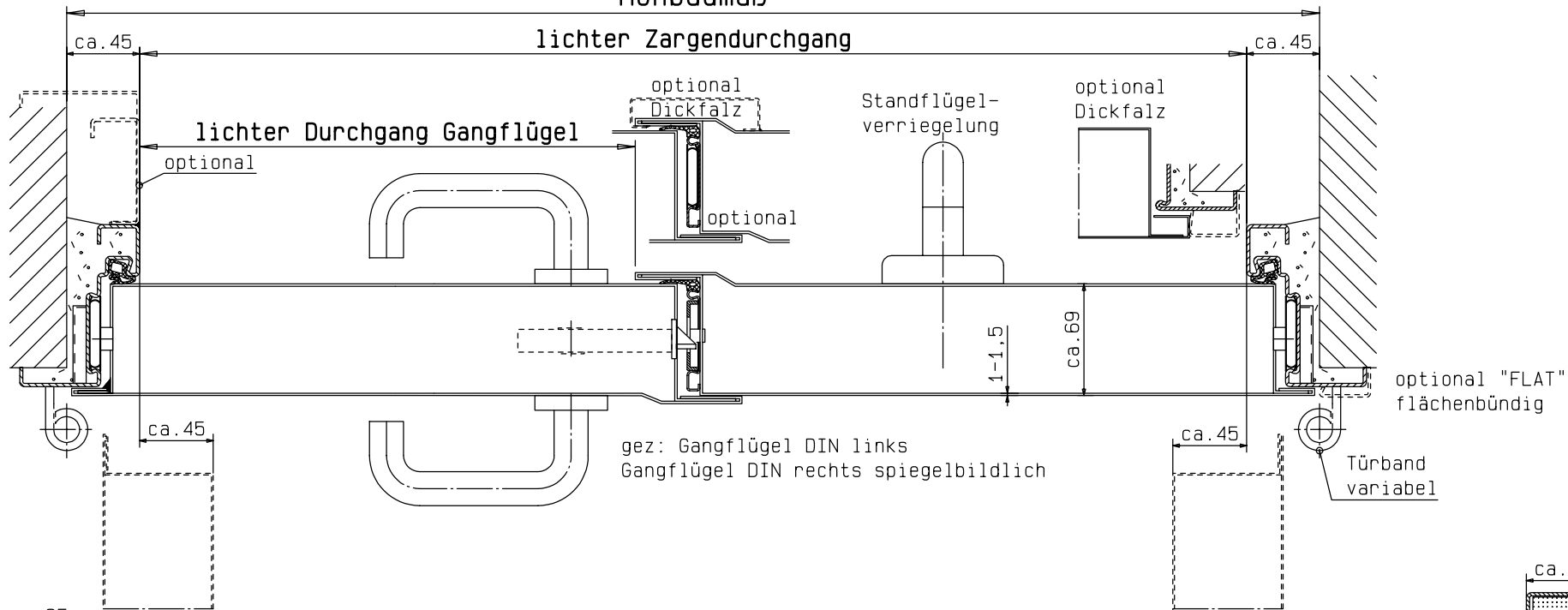
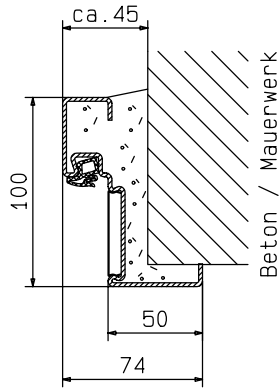

Zarge "ZNG 58/76", optional bei Dickfalz

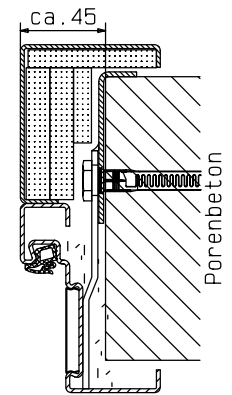
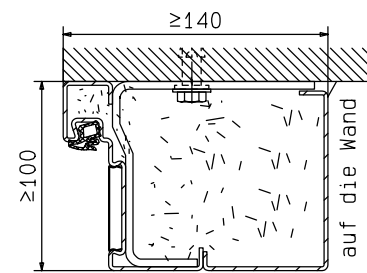
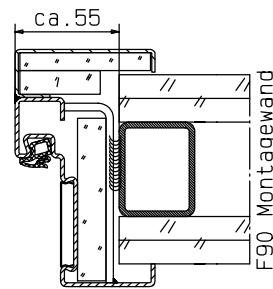
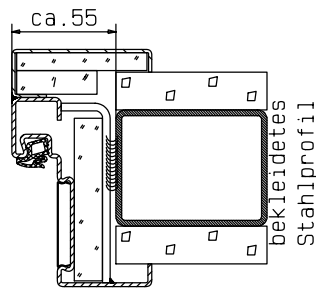

Detail Verglasung
siehe Vertikalschnitt

01.07.2020

System Schröders
Innovation Tür und Tor

Gerhard-Welter-Straße 7; D-41812 Erkelenz

Zweiflügelige Feuerschutztür
EI290/E90/EW60-C5-Sa(S200)
"System Schröders TSN-12"
Horizontalschnitt

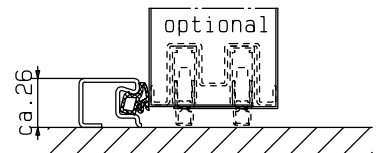
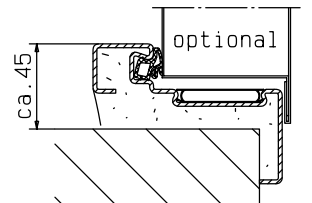
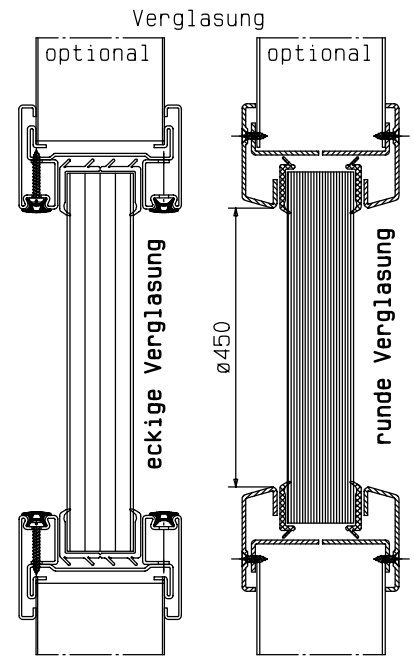
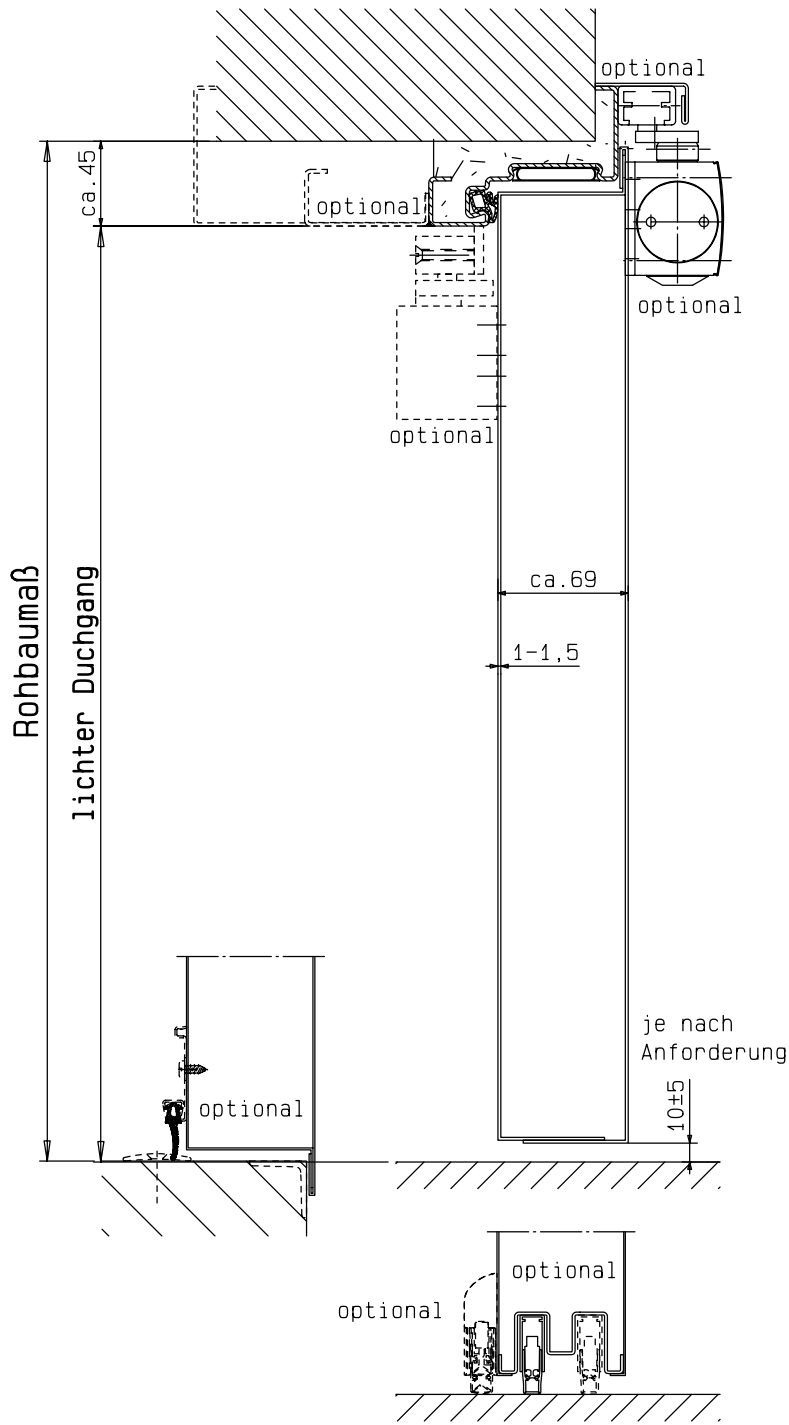

Auch lieferbar als Aussentür
mit CE Kennzeichen gem. EN 14351-1

Einbau- bzw. Zargenvarianten
siehe Horizontalschnitt

System Schröders
Innovation Tür und Tor

Gerhard-Welter-Straße 7; D-41812 Erkelenz

Zweiflügelige Feuerschutztür
EI290/E90/EW60-C5-Sa(S207)
"System Schröders TSN-12"
Vertikalschnitt